

2009-2010
Catalogue (EN)



LV Capacitor























CHINT Electric

CHINT Low-voltage Electrical Products

Zhejiang CHINT Electrics Co., Ltd, the business unit of CHINT for Low-voltage Electrical Products, is a nationwide leader in power distribution and industrial control industry and is one of the core businesses of CHINT Group. The product lines cover low-voltage electrical products of circuit breakers, contactors, pushbuttons, switches, transformers, relays, capacitors, motor starters, etc. The company adopts an ERP system by SAP and automatic warehouse guarantee just-in-time operations and lead-time. Many of CHINT Low-voltage electrical products have been certified under important international certificates such as CE, DNV, AENOR, KEMA, ASTA, VDE, TÜV, SEMKO, FIMKO, CCC, EK, ESC, SNI, UKrSEPRO, GOST, RCC, SLSI, SAA, UL, CSA, etc. Exquisitely manufactured and strictly tested, CHINT Low-voltage Electrical Products will meet your various demands for industrial, commercial, and residential applications on reliable operations and considerate before & after-sale services.

**Chint products are certified
by the following
international certificates:**

	EU	
	Norway	
	Spain	
	Netherlands	
	UK	
	Germany	
	Germany	
	Sweden	
	Finland	
	China	
	Korea	
	Czech	
	Indonesia	
	Ukraine	
	Russia	
RCC	South Africa	
	Sri Lanka	
SAA	Australia	
	USA	
	Canada	

LV Capacitor

Self-heating Shunt Capacitor



BZMJ

Page I-01



NWC1

Page I-04



NWC5

Page I-07

Intelligent Reactive Power Compensation Controller



JKF8

Page I-09



BZMJ series Self-healing Shunt Capacitor

1. General

- 1.1 Electric ratings: $\leq AC1000V$;
- 1.2 Application: For improvement of power factor and power quality
- 1.3 Standards: IEC/EN 60831-1:1996

2. Type designation

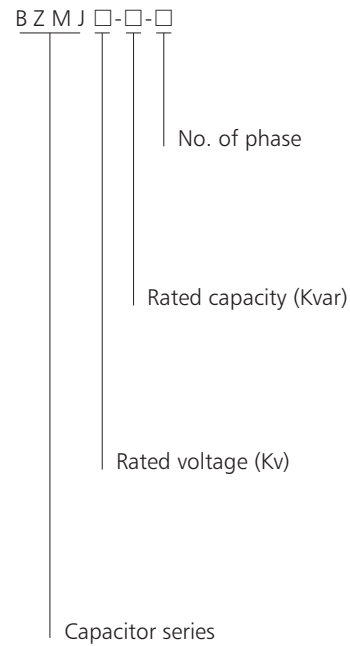

3. Normal operation & mounting conditions

- 3.1 Ambient temperature: $-25^{\circ}C \sim +50^{\circ}C$
- 3.2 Relative humidity: $\leq 50\%$ at $40^{\circ}C$, $\leq 90\%$ at $20^{\circ}C$
- 3.3 Altitude: $\leq 2000m$
- 3.4 Environmental conditions:
without dangerous gas & steam,
insulated and explosive dust
and dramatic mechanical vibration.

4. Technical data

- 4.1 Rated voltage: $AC0.23 \sim 1.0kV$
- 4.2 Rated frequency: 50Hz or 60Hz.
- 4.3 Rated capacity: $1 \sim 60Kvar$
- 4.4 Capacity error: $-5 \sim +10\%$
- 4.5 Dielectric loss tangent value: ≤ 0.0012 ,
at rated power frequency voltage.
- 4.6 Max. Allowed over-voltage: $1.1U_n$
- 4.7 Max. Allowed over-current: $1.3I_n$
- 4.8 Having Self-discharging property: power off,
voltage reduces from $\sqrt{2} U_n$ to 75V and below within 3min.
- 4.9 Specific data

Serial number	Type and Specification	Rated voltage (kV)	Rated capacity (kvar)	Rated frequency (Hz)	Rated capacitor (μF)	Rated current (A)	Enclosure height (mm)	Figure
1	BZMJ 0.23-5-3	0.23	5	50	301	12.5	190	Fig1
2	BZMJ 0.23-6-3	0.23	6	50	361	15.1	220	Fig1
3	BZMJ 0.23-7.5-3	0.23	7.5	50	451	18.8	195	Fig2
4	BZMJ 0.23-10-3	0.23	10	50	602	25.1	220	Fig2
5	BZMJ 0.23-12-3	0.23	12	50	722	30.1	250	Fig2
6	BZMJ 0.23-15-3	0.23	15	50	903	37.7	250	Fig2
7	BZMJ 0.23-20-3	0.23	20	50	1203	50.2	315	Fig3
8	BZMJ 0.4-3-3	0.4	3	50	60	4.3	120	Fig1
9	BZMJ 0.4-5-3	0.4	5	50	99	7.2	120	Fig1
10	BZMJ 0.4-6-3	0.4	6	50	119	8.7	120	Fig1
11	BZMJ 0.4-7.5-3	0.4	7.5	50	149	10.8	120	Fig1
12	BZMJ 0.4-8-3	0.4	8	50	159	11.5	120	Fig1
13	BZMJ 0.4-10-3	0.4	10	50	199	14.4	140	Fig1
14	BZMJ 0.4-12-3	0.4	12	50	239	17.3	190	Fig1
15	BZMJ 0.4-14-3	0.4	14	50	279	20.2	190	Fig1
16	BZMJ 0.4-15-3	0.4	15	50	298	21.7	190	Fig1
17	BZMJ 0.4-16-3	0.4	16	50	318	23.1	190	Fig1
18	BZMJ 0.4-18-3	0.4	18	50	358	26.0	220	Fig1
19	BZMJ 0.4-20-3	0.4	20	50	398	28.9	220	Fig1
20	BZMJ 0.4-25-3	0.4	25	50	497	36.1	220	Fig2
21	BZMJ 0.4-30-3	0.4	30	50	597	43.3	250	Fig2
22	BZMJ 0.4-40-3	0.4	40	50	796	57.7	250	Fig3
23	BZMJ 0.4-50-3	0.4	50	50	995	72.2	315	Fig3
24	BZMJ 0.4-60-3	0.4	60	50	1194	86.6	315	Fig3
25	BZMJ 0.45-3-3	0.45	3	50	47	3.8	120	Fig1
26	BZMJ 0.45-5-3	0.45	5	50	79	6.4	120	Fig1
27	BZMJ 0.45-6-3	0.45	6	50	94	7.7	120	Fig1
28	BZMJ 0.45-7.5-3	0.45	7.5	50	118	9.6	120	Fig1
29	BZMJ 0.45-8-3	0.45	8	50	126	10.3	120	Fig1
30	BZMJ 0.45-10-3	0.45	10	50	157	12.8	140	Fig1
31	BZMJ 0.45-12-3	0.45	12	50	189	15.4	190	Fig1
32	BZMJ 0.45-14-3	0.45	14	50	220	18.0	190	Fig1
33	BZMJ 0.45-15-3	0.45	15	50	236	19.2	190	Fig1
34	BZMJ 0.45-16-3	0.45	16	50	252	20.5	190	Fig1
35	BZMJ 0.45-18-3	0.45	18	50	283	23.1	220	Fig1
36	BZMJ 0.45-20-3	0.45	20	50	314	25.7	220	Fig1
37	BZMJ 0.45-25-3	0.45	25	50	393	32.1	220	Fig2
38	BZMJ 0.45-30-3	0.45	30	50	472	38.5	250	Fig2
39	BZMJ 0.45-40-3	0.45	40	50	629	51.3	250	Fig3
40	BZMJ 0.45-50-3	0.45	50	50	786	64.2	315	Fig3
41	BZMJ 0.45-60-3	0.45	60	50	943	77.0	315	Fig3
42	BZMJ 0.525-5-3	0.525	5	50	58	5.5	120	Fig1
43	BZMJ 0.525-10-3	0.525	10	50	115	11.0	140	Fig1
44	BZMJ 0.525-15-3	0.525	15	50	173	16.5	190	Fig1
45	BZMJ 0.525-20-3	0.525	20	50	231	22.0	220	Fig1
46	BZMJ 0.525-25-3	0.525	25	50	289	27.5	220	Fig2
47	BZMJ 0.525-30-3	0.525	30	50	346	33.0	250	Fig2
48	BZMJ 0.525-40-3	0.525	40	50	462	44.0	250	Fig3
49	BZMJ 0.525-50-3	0.525	50	50	577	55.0	315	Fig3
50	BZMJ 0.525-60-3	0.525	60	50	693	66.0	315	Fig3

Serial number	Type and Specification	Rated voltage (kV)	Rated capacity (kvar)	Rated frequency (Hz)	Rated capacitor (μF)	Rated current (A)	Enclosure height (mm)	Figure
51	BZMJ 0.69-5-3	0.69	5	50	33	4.2	120	Fig1
52	BZMJ 0.69-10-3	0.69	10	50	67	8.4	140	Fig1
53	BZMJ 0.69-15-3	0.69	15	50	100	12.6	190	Fig1
54	BZMJ 0.69-20-3	0.69	20	50	134	16.7	220	Fig1
55	BZMJ 0.69-25-3	0.69	25	50	167	20.9	220	Fig2
56	BZMJ 0.69-30-3	0.69	30	50	201	25.1	250	Fig2
57	BZMJ 0.69-40-3	0.69	40	50	267	33.5	250	Fig3
58	BZMJ 0.69-50-3	0.69	50	50	334	41.8	315	Fig3
59	BZMJ 0.69-60-3	0.69	60	50	401	50.2	315	Fig3
60	BZMJ 1.14-10-3	1.14	10	50	25	5.1	220	Fig1
61	BZMJ 1.14-15-3	1.14	15	50	37	7.6	250	Fig2
62	BZMJ 0.4-7.5-3YN	0.4	7.5	50	149	10.8	195	Fig2*
63	BZMJ 0.4-10-3YN	0.4	10	50	199	14.4	220	Fig2*
64	BZMJ 0.4-15-3YN	0.4	15	50	298	21.7	250	Fig2*
65	BZMJ 0.4-20-3YN	0.4	20	50	398	28.9	315	Fig3*

Note: The specifications marked with "*" are used for compensating the individual phase, the bigger one of the four terminals should be connected to the neutral line.

5. Features

- 5.1 Compact design and reliable quality thanks to advanced technology and excellent imported material;
- 5.2 Available for use in places with higher ambient temperature and voltage variation ;
- 5.3 Having good sealing properties; amd outgoing terminals for convenient wiring and reliable connection;
- 5.4 Fixed type, convenient for mounting and elegant appearance due to novel mounting pins;
- 5.5 No painting thanks to coated metal Enclosure used ;

6. Notices

- 6.1 Please guarantee that the capacitors are operated under specified conditions, including the proper temperature, voltage and current, as over-voltage and over-current may shorten the life of the capacitor;
- 6.2 Please pay attention to the points following when the capacitor is shuntly connected in the system
 - a. For the system of current regulating system and the electric equipments system, the capacitor should not be directly connected;
 - b. Operational current of the capacitor should be less than the off-load current of the shuntly connected motor;
 - c. When the transformer is off-load, the capacitor should stop operating.
- 6.3 Specific switches, contactors and over-current relays should be adopted when the capacitor is shuntly connected in the system.

7. Overall and mounting dimensions (mm)

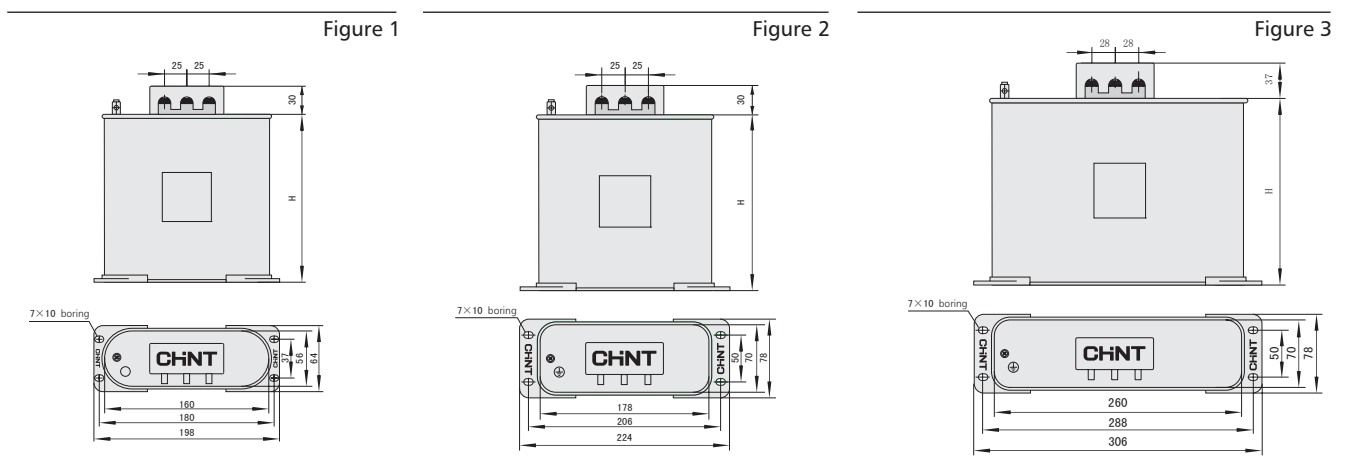



NWC1 series Self-healing Shunt Capacitor

1. General

- 1.1 Electric ratings: \leq AC1000V;
- 1.2 Application: For improvement of power factor and power quality;
- 1.3 Standards: IEC/EN 60831-1: 1996

2. Type designation

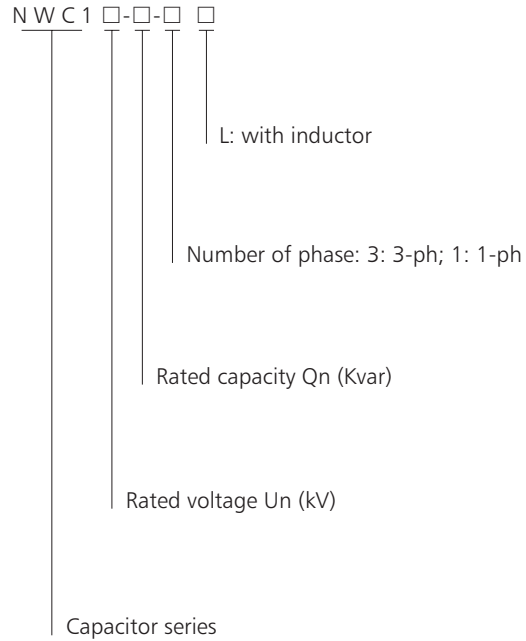

3. Normal operation & mounting conditions

- 3.1 Ambient temperature: $-25^{\circ}\text{C} \sim +50^{\circ}\text{C}$
- 3.2 Relative humidity: $\leq 50\%$ at 40°C , $\leq 90\%$ at 20°C
- 3.3 Altitude: $\leq 2000\text{m}$
- 3.4 Environmental conditions:
without dangerous gas & steam,
insulated and explosive dust
and dramatic mechanical vibration.

4. Technical data

- 4.1 Rated voltage: 0.4, 0.415, 0.45, 0.525 and 0.69kV
- 4.2 Rated frequency: 50Hz or 60Hz.
- 4.3 Rated capacity: 5~40Kvar
- 4.4 Capacity error: $-5\% \sim +10\%$;
- 4.5 Dielectric loss tangent value: ≤ 0.0012 ,
at rated power frequency voltage
- 4.6 Max. allowed over-voltage: $1.1U_n$, not exceed 8h in 24h
- 4.7 Max. allowed over-current: $1.3I_n$
- 4.8 Having Self-discharging property: power off,
voltage reduces from $\sqrt{2} U_n$ (DC) to 75V
and below within 3min .
- 4.9 Model and Specifications

Serial number	Type and Specification	Rated voltage (kV)	Rated capacity (kvar)	Rated frequency (Hz)	Rated capacitor (μF)	Rated current (A)	Enclosure height (mm)	Figure
1	NWC1-0.4-5-3	0.4	5	50	99	7.2	160	Fig1
2	NWC1-0.4-6-3	0.4	6	50	119	8.7	160	Fig1
3	NWC1-0.4-7.5-3	0.4	7.5	50	149	10.8	160	Fig1
4	NWC1-0.4-8-3	0.4	8	50	159	11.5	160	Fig1
5	NWC1-0.4-10-3	0.4	10	50	199	14.4	160	Fig1
6	NWC1-0.4-12-3	0.4	12	50	239	17.3	220	Fig1
7	NWC1-0.4-14-3	0.4	14	50	279	20.2	220	Fig1
8	NWC1-0.4-15-3	0.4	15	50	298	21.7	220	Fig1
9	NWC1-0.4-16-3	0.4	16	50	318	23.1	220	Fig1
10	NWC1-0.4-18-3	0.4	18	50	358	26.0	260	Fig1
11	NWC1-0.4-20-3	0.4	20	50	398	28.9	260	Fig1
12	NWC1-0.4-24-3	0.4	24	50	477	34.6	230	Fig2
13	NWC1-0.4-25-3	0.4	25	50	497	36.1	230	Fig2
14	NWC1-0.4-30-3	0.4	30	50	597	43.3	230	Fig2
15	NWC1-0.4-35-3	0.4	35	50	696	50.5	270	Fig2
16	NWC1-0.4-40-3	0.4	40	50	796	57.7	270	Fig2
17	NWC1-0.45-5-3	0.45	5	50	79	6.4	160	Fig1
18	NWC1-0.45-6-3	0.45	6	50	94	7.7	160	Fig1
19	NWC1-0.45-7.5-3	0.45	7.5	50	118	9.6	160	Fig1
20	NWC1-0.45-8-3	0.45	8	50	126	10.3	160	Fig1
21	NWC1-0.45-10-3	0.45	10	50	157	12.8	160	Fig1
22	NWC1-0.45-12-3	0.45	12	50	189	15.4	220	Fig1
23	NWC1-0.45-14-3	0.45	14	50	220	18.0	220	Fig1
24	NWC1-0.45-15-3	0.45	15	50	236	19.2	220	Fig1
25	NWC1-0.45-16-3	0.45	16	50	252	20.5	220	Fig1
26	NWC1-0.45-18-3	0.45	18	50	283	23.1	260	Fig1
27	NWC1-0.45-20-3	0.45	20	50	314	25.7	260	Fig1
28	NWC1-0.45-24-3	0.45	24	50	377	30.8	230	Fig2
29	NWC1-0.45-25-3	0.45	25	50	393	32.1	230	Fig2
30	NWC1-0.45-30-3	0.45	30	50	472	38.5	230	Fig2
31	NWC1-0.45-35-3	0.45	35	50	550	44.9	270	Fig2
32	NWC1-0.45-40-3	0.45	40	50	629	51.3	270	Fig2
33	NWC1-0.525-5-3	0.525	5	50	58	5.5	160	Fig1
34	NWC1-0.525-6-3	0.525	6	50	69	6.6	160	Fig1
35	NWC1-0.525-7.5-3	0.525	7.5	50	87	8.2	160	Fig1
36	NWC1-0.525-8-3	0.525	8	50	92	8.8	160	Fig1
37	NWC1-0.525-10-3	0.525	10	50	115	11.0	160	Fig1
38	NWC1-0.525-12-3	0.525	12	50	139	13.2	220	Fig1
39	NWC1-0.525-14-3	0.525	14	50	162	15.4	220	Fig1
40	NWC1-0.525-15-3	0.525	15	50	173	16.5	220	Fig1
41	NWC1-0.525-16-3	0.525	16	50	185	17.6	220	Fig1
42	NWC1-0.525-18-3	0.525	18	50	208	19.8	260	Fig1
43	NWC1-0.525-20-3	0.525	20	50	231	22.0	260	Fig1
44	NWC1-0.525-24-3	0.525	24	50	277	26.4	230	Fig2
45	NWC1-0.525-25-3	0.525	25	50	289	27.5	230	Fig2
46	NWC1-0.525-30-3	0.525	30	50	346	33.0	230	Fig2
47	NWC1-0.525-35-3	0.525	35	50	404	38.5	270	Fig2
48	NWC1-0.525-40-3	0.525	40	50	462	44.0	270	Fig2
49	NWC1-0.69-5-3	0.69	5	50	33	4.2	160	Fig1
50	NWC1-0.69-6-3	0.69	6	50	40	5.0	160	Fig1

Serial number	Type and Specification	Rated voltage (kV)	Rated capacity (kvar)	Rated frequency (Hz)	Rated capacitor (μF)	Rated current (A)	Enclosure height (mm)	Figure
51	NWC1-0.69-7.5-3	0.69	7.5	50	50	6.3	160	Fig1
52	NWC1-0.69-8-3	0.69	8	50	53	6.7	160	Fig1
53	NWC1-0.69-10-3	0.69	10	50	67	8.4	160	Fig1
54	NWC1-0.69-12-3	0.69	12	50	80	10.0	220	Fig1
55	NWC1-0.69-14-3	0.69	14	50	94	11.7	220	Fig1
56	NWC1-0.69-15-3	0.69	15	50	100	12.6	220	Fig1
57	NWC1-0.69-16-3	0.69	16	50	107	13.4	220	Fig1
58	NWC1-0.69-18-3	0.69	18	50	120	15.1	260	Fig1
59	NWC1-0.69-20-3	0.69	20	50	134	16.7	260	Fig1
60	NWC1-0.69-24-3	0.69	24	50	160	20.1	230	Fig2
61	NWC1-0.69-25-3	0.69	25	50	167	20.9	230	Fig2
62	NWC1-0.69-30-3	0.69	30	50	201	25.1	230	Fig2
63	NWC1-0.69-35-3	0.69	35	50	234	29.3	270	Fig2
64	NWC1-0.69-40-3	0.69	40	50	267	33.5	270	Fig2
65	NWC1-0.4-50-3	0.4	50	50	995	72.2	330	Fig3
66	NWC1-0.4-60-3	0.4	60	50	1194	86.6	330	Fig3
67	NWC1-0.4-80-3	0.4	80	50	1591	115.5	440	Fig3
68	NWC1-0.4-100-3	0.4	100	50	1990	144.3	550	Fig3
69	NWC1-0.4-120-3	0.4	120	50	2387	173.2	550	Fig3

5. Notices

- 5.1 Please guarantee that the capacitors are operated under specified conditions, including the proper temperature, voltage and current, as over-voltage and over-current may shorten the life of the capacitor;
- 5.2 Please pay attention to the points following when the capacitor is shuntly connected in the system
 - a. For the system of current regulating system and the electric equipments system, the capacitor should not be directly connected;
 - b. Operational current of the capacitor should be less than the off-load current of the shuntly connected motor;
 - c. When the transformer is off-load, the capacitor should stop operating.
- 5.3 Specific switches, contactors and over-current relays should be adopted when the capacitor is shuntly connected in the system.

6. Overall and mounting dimensions (mm)

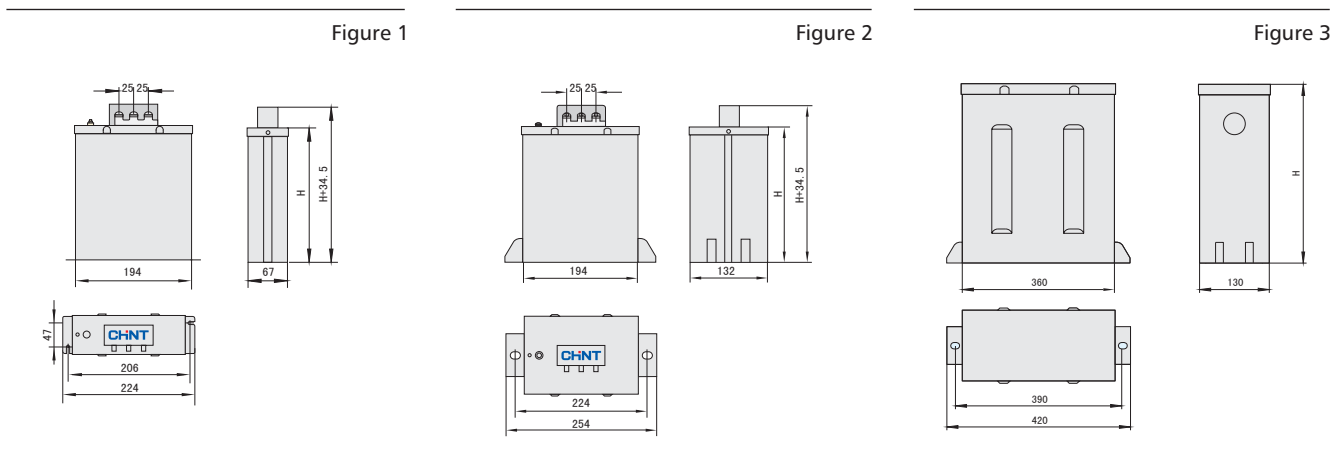

7. Ordering information

On ordering, please clarify rated voltage, capacity, number of phase, frequency, etc of the products; and associated conditions at the mounting place.



NWC5 series Self-healing Shunt Capacitor

1. General

- 1.1 Electric ratings: \leq AC1000V.
- 1.2 Application: Newly developed energy-saving product for improvement of power factor and power quality;
- 1.3 Standards: IEC/EN 60831-1996

2. Type designation

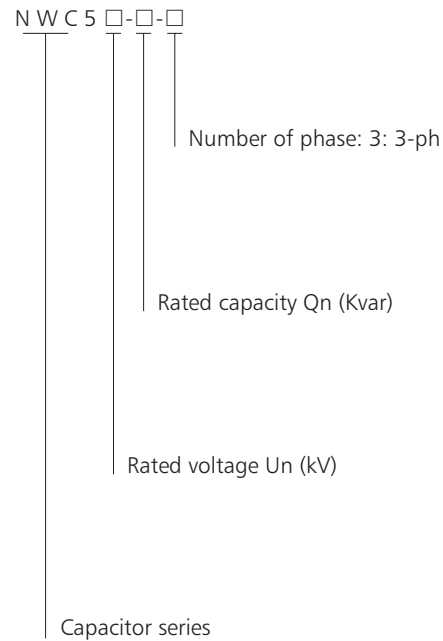

3. Normal operation & mounting conditions

- 3.1 Ambient temperature: $-25^{\circ}\text{C} \sim +50^{\circ}\text{C}$
- 3.2 Relative humidity: $\leq 50\%$ at 40°C , $\leq 90\%$ at 20°C
- 3.3 Altitude: $\leq 2000\text{m}$
- 3.4 Environmental conditions: without dangerous gas & steam, insulated and explosive dust and dramatic mechanical vibration.

4. Technical data

- 4.1 Rated voltage: 0.4, , 0.45, 0.525kV
- 4.2 Rated frequency: 50Hz or 60Hz.
- 4.3 Rated capacity: 10~25Kvar
- 4.4 Capacity error: $-5 \sim +10\%$;
- 4.5 Dielectric loss tangent value: ≤ 0.0012 , at rated power frequency voltage
- 4.6 Max. allowed over-voltage: $1.1U_n$, not exceed 8h in 24h
- 4.7 Max. allowed over-current: $1.3I_n$
- 4.8 Having Self-discharging property: power off, voltage reduces from $\sqrt{2} U_n$ (DC) to 75V and below within 3min.
- 4.9 Model and Specifications

Serial number	Type and Specification	Rated voltage (kV)	Rated capacity (kvar)	Rated frequency (Hz)	Rated capacitor (μF)	Rated current (A)	Dimensions D×H(mm)	Mounting Dimensions (mm)
1	NWC5-0.4-10-3	0.4	10	50	199	14.4	φ 76×240	M12×16
2	NWC5-0.4-12-3	0.4	12	50	239	17.3	φ 76×240	
3	NWC5-0.4-14-3	0.4	14	50	279	20.2	φ 76×280	
4	NWC5-0.4-15-3	0.4	15	50	298	21.7	φ 76×280	
5	NWC5-0.4-16-3	0.4	16	50	318	23.1	φ 76×280	
6	NWC5-0.4-18-3	0.4	18	50	358	26.0	φ 86×280	
7	NWC5-0.4-20-3	0.4	20	50	398	28.9	φ 86×280	M16×25
8	NWC5-0.4-25-3	0.4	25	50	497	36.1	φ 96×280	
9	NWC5-0.45-10-3	0.45	10	50	157	12.8	φ 76×240	M12×16
10	NWC5-0.45-12-3	0.45	12	50	189	15.4	φ 76×240	
11	NWC5-0.45-14-3	0.45	14	50	220	18.0	φ 76×280	
12	NWC5-0.45-15-3	0.45	15	50	236	19.2	φ 76×280	
13	NWC5-0.45-16-3	0.45	16	50	252	20.5	φ 76×280	
14	NWC5-0.45-18-3	0.45	18	50	283	23.1	φ 86×280	
15	NWC5-0.45-20-3	0.45	20	50	314	25.7	φ 86×280	M16×25
16	NWC5-0.45-25-3	0.45	25	50	393	32.1	φ 96×280	
17	NWC5-0.525-10-3	0.525	10	50	115	11.0	φ 76×240	M12×16
18	NWC5-0.525-12-3	0.525	12	50	139	13.2	φ 76×240	
19	NWC5-0.525-14-3	0.525	14	50	162	15.4	φ 76×280	
20	NWC5-0.525-15-3	0.525	15	50	173	16.5	φ 76×280	
21	NWC5-0.525-16-3	0.525	16	50	185	17.6	φ 76×280	
22	NWC5-0.525-18-3	0.525	18	50	208	19.8	φ 86×280	
23	NWC5-0.525-20-3	0.525	20	50	231	22.0	φ 86×280	M16×25
24	NWC5-0.525-25-3	0.525	25	50	289	27.5	φ 96×280	

5. Features

- 5.1 Safe and reliable operation because of the independent protective enclosure;
- 5.2 With good sealing properties; and outgoing terminals for convenient wiring and reliable connection;
- 5.3 Available for use in the places with higher ambient temperature and voltage variation ;
- 5.4 Fixed type, convenient for mounting and elegant appearance due o to novel mounting pins.

6. Notices

- 6.1 Please guarantee that the capacitors are operated under specified conditions, including the proper temperature, voltage and current, as over-voltage and over-current may shorten the life of the capacitor;
- 6.2 Please pay attention to the points following when the capacitor is shuntly connected in the system
 - a. For the system of current regulating system and the electric equipments system, the capacitor should not be directly connected;
 - b. Operational current of the capacitor should be less than the off-load current of the shuntly connected motor;
 - c. When the transformer is off-load, the capacitor should stop operating.
- 6.3 Specific switches, contactors and over-current relays should be adopted when the capacitor is shuntly connected in the system.

7. Overall and mounting dimensions (mm)

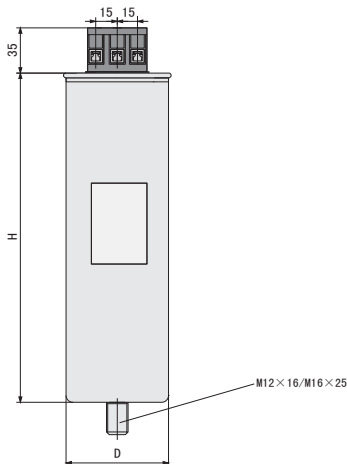



JKF8 Intelligent Low-Voltage Reactive Power Compensation Controller

1. General

JKF8 Intelligent Low-Voltage Reactive Power Compensation Controller (hereinafter referred to as "controller") is a dedicated controller which can make compensations for the reactive power of low voltage distribution system.

2. Type designation

JK F 8-□

Output loop specification

Low-Voltage

Reactive Power Compensation Controller Series

3. Features

- 3.1 With combined control on reactive power and power factor, a reliable input can be ensured under low load, and surge switching can be prevented.
- 3.2 Real-time display of the network status, including parameters such as power factor, voltage, current, active power, and reactive power, etc.
- 3.3 The polarity of the sampling signal can be automatically identified. Therefore, there is no need to worry about wrong connections with reversed polarity.
- 3.4 In case the voltage of the electrical power network is lower than 300 V, or exceeds the preset over-voltage protection value, the connected capacitor banks will be automatically and rapidly (5 sec.) disconnected in steps, and the voltage value will be displayed.
- 3.5 In case the signal from the secondary coil of the current transformer is smaller than 150 mA, the controller will prevent any more capacitor from being connected, in the mean time, automatically and rapidly (5 sec.) disconnect the connected capacitor banks step-wise.
- 3.6 Switching (opening/closing control of the contactor) prevention time for the same group of capacitors is 3 minutes (capacitor discharge duration)
- 3.7 The controller is with cyclic automated-self-test function, which facilitates the factory acceptance test for a capacitor panel.

4. Operation conditions

- 4.1 Ambient temperature: $-10^{\circ}\text{C} \sim +40^{\circ}\text{C}$
- 4.2 Relative humidity: $\leq 50\%$, when 40°C , $\leq 90\%$ when 20°C
- 4.3 Altitude: ≤ 2000 m
- 4.4 Operation environment: free of hazardous gas and/or vapor, conductive or explosive dust, or rigorous mechanical vibration.
- 4.5 Operation voltage: $400\text{VAC} \pm 10\%$

5. Technical specifications

Parameters	Technical Specifications
Sampling voltage	400VAC±10%
Sampling current	150mA~5 A
Rated frequency	50/60Hz±5%
Low-current capacitor connection prevention	≤150 mA
Current transformation ratio	Range of transformation ratio for sampling current transformer: 5~800, Preset value of the ratio (preset value in factory: 60, which means 300/5)
Time lag	5~120 seconds (preset value in factory: 30 seconds)
Preset mode	Full automation mode (displayed code F-0: 1): no need to set the capacitor connection threshold or the capacitor disconnection threshold. Manual setup mode(displayed code F-0: 0): need to set the capacitor connection threshold and the capacitor disconnection threshold manually.
Capacitor connection threshold	Full automation mode: capacitor banks in the smallest step Manual mode: preset value for reactive power: 1~120 kvar (preset value in factory: 10 kvar)
Capacitor disconnection threshold	Power factor, 0.85 ~ -0.95 continuously adjustable (preset value in factory: 1.00)
Over-voltage threshold	400 V~456 V (preset value in factory: 430 V)
Loop number	JKF8-6 (loop number can be set between 1 and 6), JKF8-12(loop number can be set between 1 and 12)
Operation mode	Automated cyclic opening/closing control & manual operation
Max. power consumption	15 W
Output contact point capacity	5A/230V(or 3A/400V)
Weighyt	Approximately1.5 Kg

6. Wiring diagram

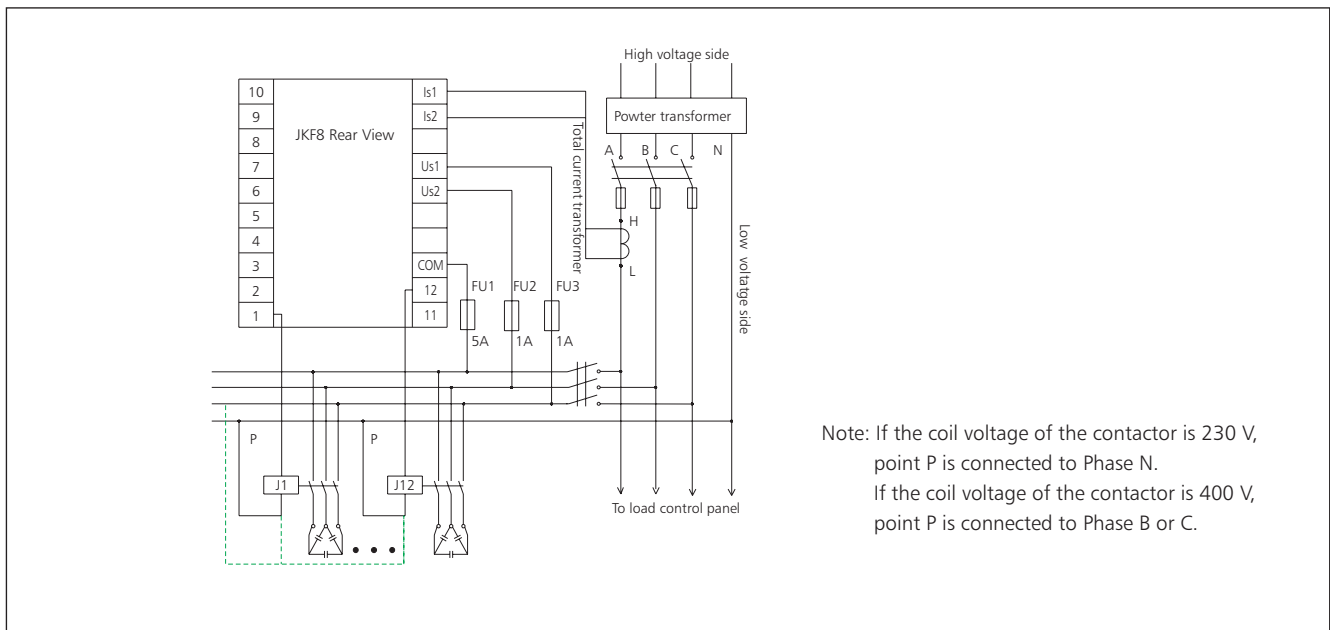

- 6.1 Connection terminal US1 and US2 are to be connected to the sampling voltage. AC 400 V shall be connected.
- 6.2 Terminal IS1 and IS2 are to be connected to the sampling current, which shall be sampled from the transformed current generated by the current transformer for the load, and which shall not be in-phase with US1 and US2 (if A is for current, then B and C are for voltage).
- 6.3 Terminal COM is the common shared terminal to be connected to number 1 to 12 relays in the output lines of the controller, and each of the terminals 1~12 is to be connected to the output control line to control the respective contactor in the respective compensation loop of the capacitor panel.
- 6.4 If the coil voltage of the contactor J is 230 V, then Point P is connected to Phase N.
If the coil voltage of the contactor J is 400 V, then Point P is connected to Phase C (as long as it is not in-phase with terminal COM).
- 6.5 FU1~3 are to be connected to fusers which are supplied by the user.

7. Description of parameters

7.1 Description of dynamic parameters

Code	Signification	Unit	Description
I	Current	A	If the measured value is out of the display range, the approximate value will be displayed, e.g., 1260 A is displayed as E13
U	Voltage	V	Display the measured voltage value
Q	Reactive power	Kvar	If the measured value is out of the display range, the approximate value will be displayed, e.g., 1360 Kvar is displayed as E14.
P	Active power	KW	If the measured value is out of the display range, the approximate value will be displayed, e.g., 1360 kW is displayed as E14.

7.2 Description of preset parameters (menu description)

Code	Description	Range of Settings	Factory Settings	Change Step	Remark
F-0	Preset mode	1 or 0	1	—	1 full automation 0 manual setup
F-1	Capacitor connection threshold	1~120 kvar	10 kvar	1 kvar	This parameter is invalid under the full automation mode
F-2	Target power factor	0.85~-0.95	1.00	0.01	“-” stands for system capacity
F-3	Switching time lag	5~120 sec .	30 sec.	1 sec.	
F-4	Over-voltage protection	400 V~456 V	430 V	2 V	Voltage difference: 8~10V
F-5	Number of control loop	1~6 or 1~12	6 or 12	1	Two types of specifications
F-6	Transformation ratio of the sampling current transformer	5~800	60	5	(300: 5)

8. Overall and Mounting Dimension (mm)

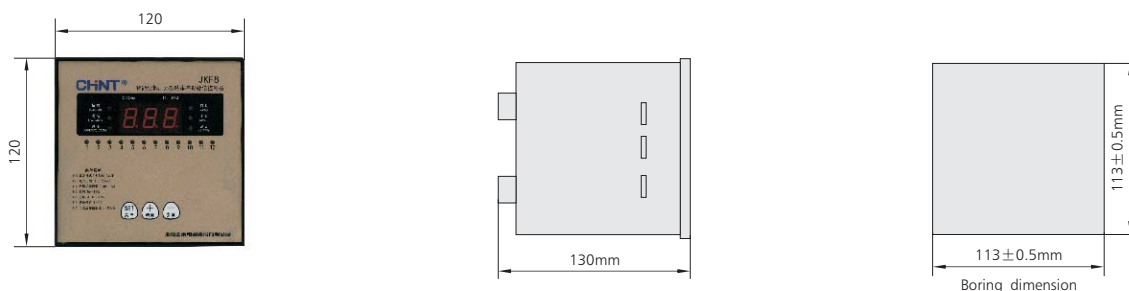



ZHEJIANG CHINT ELECTRICS CO.,LTD

Add: No. 1, CHINT Road, CHINT Industrial Zone, North Baixiang,
Yueqing, Zhejiang Province, P.R.China 325603
Tel: +86-577-62877777
Fax: +86-577-62775769 62871811
E-mail: global-sales@chint.com
Website: www.chint.com

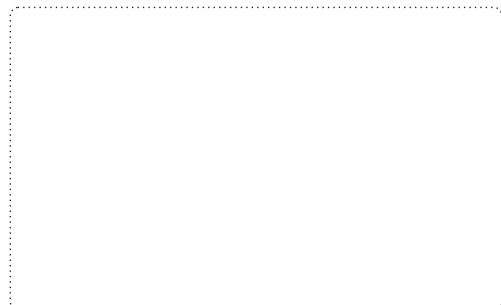

Jun 2008

© CHINT. No. 2009008EN0806